



# SILWERSTRAND

GOLF AND RIVER ESTATE

ARCHITECTURAL GUIDELINES

VILLAGE ERVEN

JUNE 2016

**SILWERSTRAND HOME OWNERS ASSOCIATION  
("SHOA")**

**ARCHITECTURAL GUIDELINES  
VILLAGE ERVEN**

**CONTENTS**

1. Introduction
2. Plan Submission Process
3. Payment of Deposit
4. Building Regulations
5. Contact Addresses
6. Special Notes
7. Building Line and Setback Requirements
8. Site and Boundary Conditions
- 9.1 Outbuildings/Garaging and Parking requirements
- 9.2 Outbuildings/Garaging and Parking requirements
- 10.1 Primary and Secondary Building Forms
- 10.2 Control of Wall Lengths
11. Treatment of Gable Ends
12. Verandahs
- 13.1 Openings
- 13.2 Openings
- 13.3 Openings
14. Fascias/Parapets Walls & Eaves
- 15.1 Pergolas and Canopies
- 15.2 Pergolas and Canopies
16. Fences/Gates and Wall Cladding Materials
17. Boundary walls
18. Materials and Finishes
19. Colour Schedules
20. External Lighting
21. External Signage
22. Services
23. ADDENDUMS 1-8

## **GUIDELINES TO ADDITIONS & ALTERATIONS**

### **1. INTRODUCTION**

Within the Silverstrand Golf & River Estate there exists architecturally a strong built form originating from the surrounding farm buildings and shaped by the climate, the local economy and availability of materials.

It is the intention of these SHOA Design Guidelines to Additions & Alterations to encourage continued use of these forms – this, combined with more specific contemporary elements and colours, will ensure that a unique, simple yet fitting overall appearance with a common thread of design is retained (each part of the Development has an individual style).

Alongside more specific controls set out in this Document – all proposed additions and alterations should utilise the following themes to retain a successful inclusion of the overall Development:

- Simple rectangular built forms interlinked where required creating protected external spaces.
- Courtyard spaces for private entertainment areas and entrances etc.
- Pergolas, planted with vine for shade – giving shade in the summer when the vines have leaves and sun penetration in the winter months when bare.
- Loft spaces utilized for economy of space (with suitable thermal insulation).
- Canopy roofs / shutters and louvers to exposed windows and doors for sun protection.
- Thick masonry walls for passive internal thermal control.
- Tiled floors for thermal comfort.
- Timber screens for privacy and wind protection.

### **2. PLAN SUBMISSION PROCESS**

Plans must be prepared by a registered SACAP Professionals.

Should landscaping be required, refer to the SHOA Landscaping Guidelines.

The Scrutiny Fee is R2700.00. This will cover the Architectural plan scrutiny for the Development only NOT council.

#### Plan Submission Process

- A Black and White PDF copy of the plans must be submitted to [plans@silverstrand.co.za](mailto:plans@silverstrand.co.za) for scrutiny.
- The SHOA will then issue an invoice to the owner for the cost of the Submission, the Wear & Tear levy and the Water meter. All fees must be paid prior to the plans being sent to the Controlling Architect.
- Once the confirmation of payment has been received, the Estate Manager will submit the PDF plans to the Controlling Architect via email for his scrutiny, comments and approval.
- The Controlling Architect will then have 7 days from receipt of the plans to scrutinize the plans and provide feedback and motivation for any deviations, to the Trustees.
- The Controlling Architect will then issue a suitable letter regarding the submitted plans to the owner.
- Once the plans are compliant with the requirements of the Architectural and Landscaping Guidelines, the coloured plans will then be stamped by the Estate Manager and may then be submitted, along with all supporting documents to the Langeberg Municipality for approval.

Upon Approval and stamping of the plans, 3 sets of plans may be collected (2 sets will be retained on file). These drawings can then be coloured and submitted by the owners or their representative to the Robertson Municipality (it must be noted that the services of a structural engineer or other professionals may also be required – this being to the account of the client).

## **CONFIRMATION OF COMPLIANCE WITH APPROVED DRAWINGS**

Prior to an Occupancy Certificate being issued by the building inspector a final inspection of the works will take place.

**There should be no changes to the original approved and stamped drawings otherwise the certificate will not be issued and occupation of the dwelling may not take place. Unapproved changes to the Municipal approved plans will receive a fine of R5000.00 and building work will be stopped until the necessary approvals are obtained.**

### **3. PAYMENT OF VERGE DEPOSIT AND WEAR & TEAR LEVY**

Wear and Tear Levy – R 3500.00 (non-refundable) – payable by Owner.  
Water meter – R650 (non-refundable) – payable by Owner.  
Verge Deposit – R 3000.00 (refundable) – payable by Contractor.  
Contractor Advertising Board – R1450 (non-refundable) – payable by Contractor

The Contractor Deposit and Advertising Board are paid with the signing of the Contractors Agreement.

The Wear & Tear Levy and the Water meter are paid when the owner / architect submits plans for scrutiny.

### **4. BUILDING REGULATIONS**

In addition to the standards as set out in these Design Guidelines all of the National Building Regulations and all Local Authority Statutory Regulations must be adhered to at all times.

### **5. CONTACT ADDRESSES**

Silwerstrand Home Owners' Association  
26 Silwerstrand Boulevard  
Silwerstrand Estate  
Robertson, 6705  
PO BOX 227, Robertson, 6705  
082 747 2553  
[plans@silwerstrand.co.za](mailto:plans@silwerstrand.co.za)

### **6. SPECIAL NOTES / ARCHITECTURAL APPOINTMENTS**

#### **Amendments to SHOA Guidelines to Additions & Alterations**

The SHOA Trustees reserve the right to amend these guidelines at any time.

#### **Waivers to plans**

The control Architects reserve the right to approve specific waivers in terms of these guidelines should Architectural merit be identified

Should any waivers be granted in terms of these guidelines then this will not set a precedent for future plan submissions in any way whatsoever

#### **Professional Fees**

Professional fees and Submission fees etc will be subject to change

**7. Building Line and Setback Requirements**

<b>Setbacks</b>	<b>Roadside</b>	<b>Farmland Open Space</b>	<b>Sidespace</b>
Primary Roof Forms – Roofs with 35 - 42.5 deg pitch	5.0m	5.0m	3.0m
Secondary Roof Forms – Roofs with 0 - 17.5 deg pitch Yards/Screened seating areas Outbuilding	3.0m	1.0m	Min 1m – Sum of sides to be min 3m
Garages/Carports	1.5m	5.0m	Zero except within the first 5m of the Roadside Boundary where 1m shall apply
Swimming Pools	3m	1.2m	1.2m

**Coverage**

Maximum coverage on any of the erven shall be 60% of the plot area.

The following elements shall be included in the coverage calculation:

- The Primary and Secondary roofed building forms and roofed garages and stoeps/verandahs.
- Exclude all pergolas and yards / open paved areas and courtyards.

**Building Alignment**

Generally all buildings are to align with the surrounding square boundary lines. In the case of a plot that has an angled boundary the building may align to that angle either totally or on that particular edge of the building.

8. Site and Boundary Conditions

Village area,

TYPICAL PLAN LAYOUT:

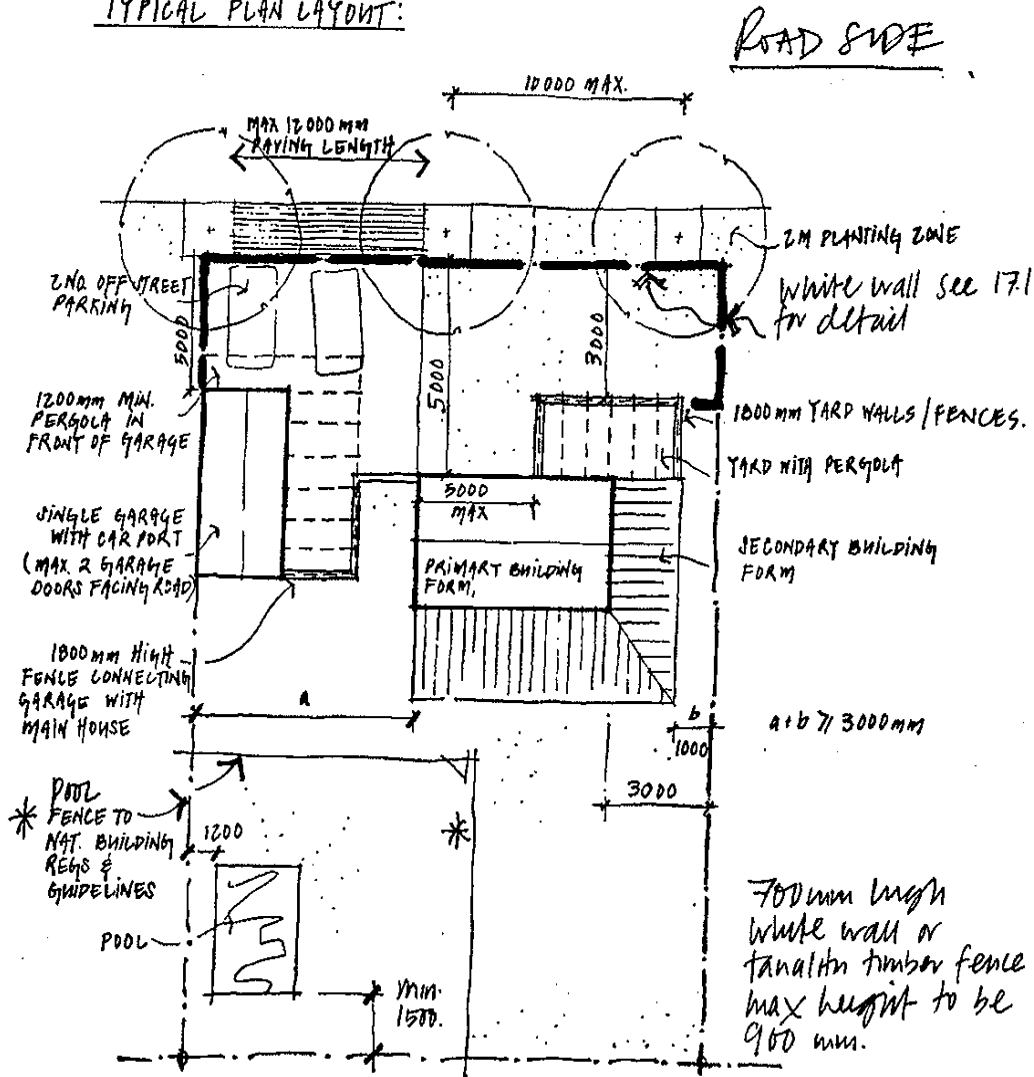

NOTE :

AREAS -- MIN. SIZE OF HOME ONLY TO BE 45m<sup>2</sup> EXCL. STEEPS ETC.  
 MAX. COVERAGE = 60% OF ERF AREA

9.1 Outbuildings/Garaging and Parking requirements

TYPICAL PARKING ARRANGEMENTS - DOUBLE OR SINGLE GARAGES, WITH OR WITHOUT CARPORT / PERGOLAS

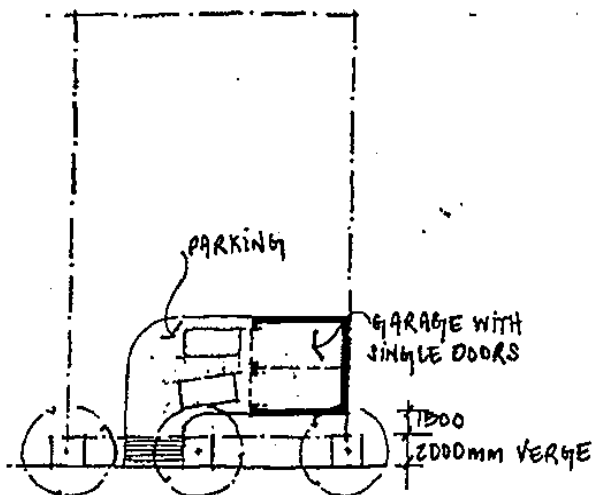
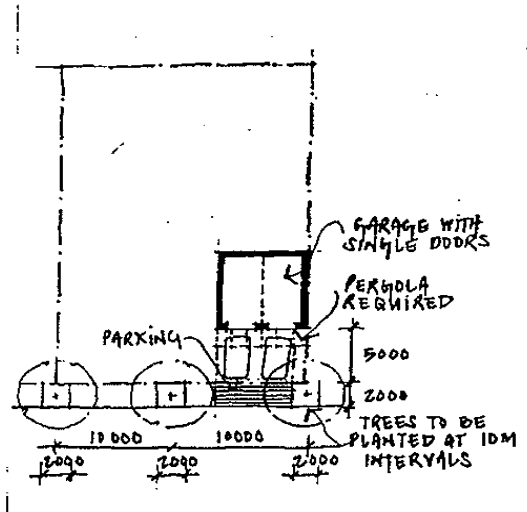
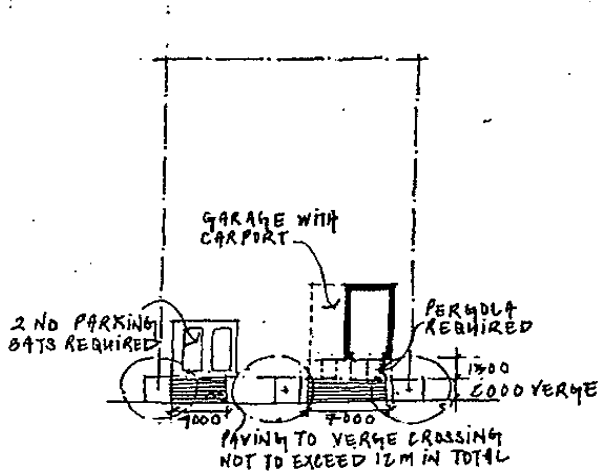

- 2 NO OFF STREET PARKING SPACES ARE REQUIRED IN ADDITION TO ANY GARAGING / CARPORTS
- ALL TREE POSITIONS IN VERGE AREA A TO BE RESPECTED IN THE DESIGN OF SITE ACCESS
- ONLY 2 NO GARAGE DOORS (ALL SINGLE) ARE TO FACE THE ROAD ON ANY SINGLE ERF
- ALL GARAGE STRUCTURE TO THE FOLLOWING DETAILS

9.2 Outbuildings/Garaging and Parking requirements

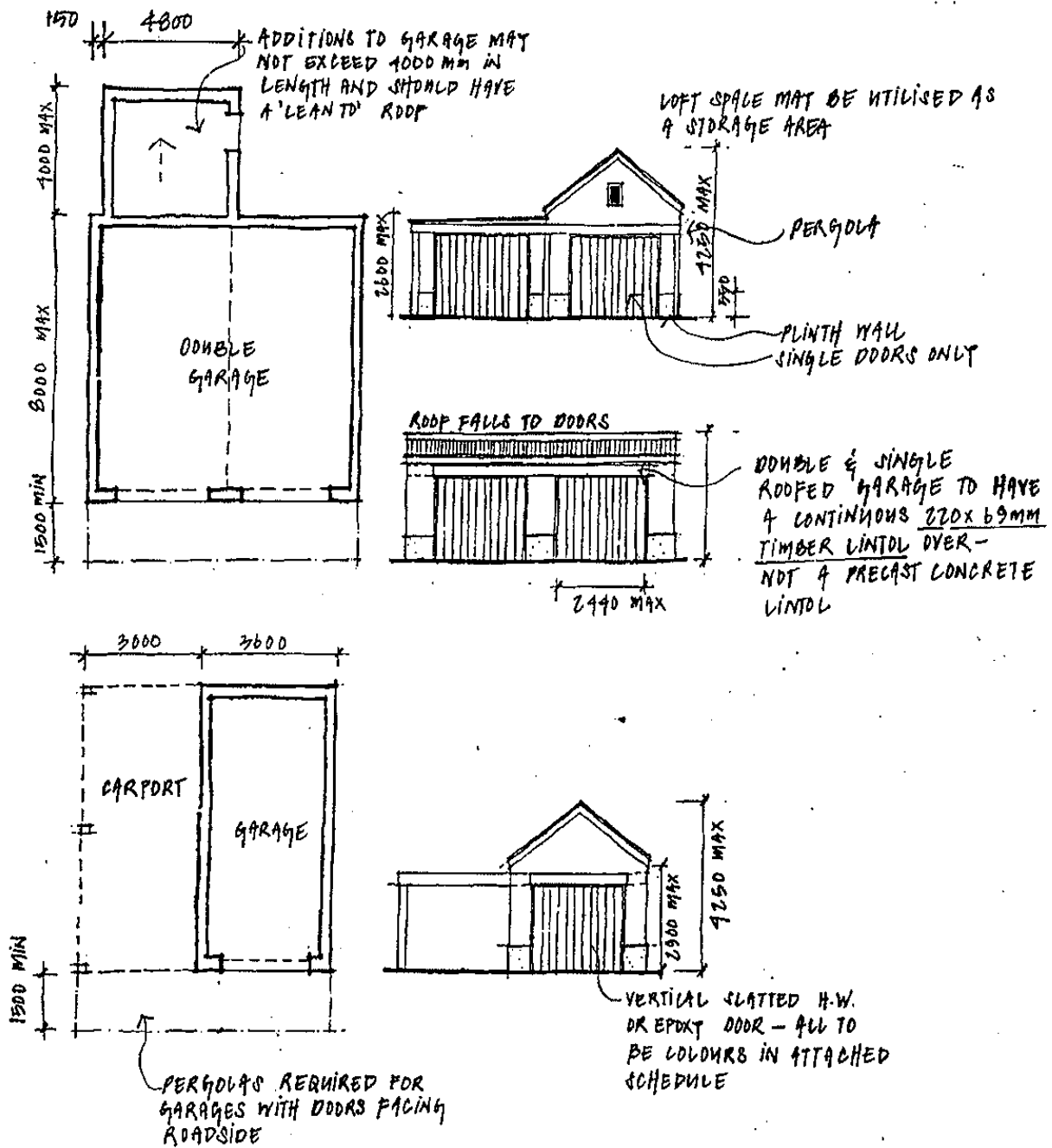



## 10.1 Primary and Secondary Building Forms

### TYPICAL PLAN FORMS:

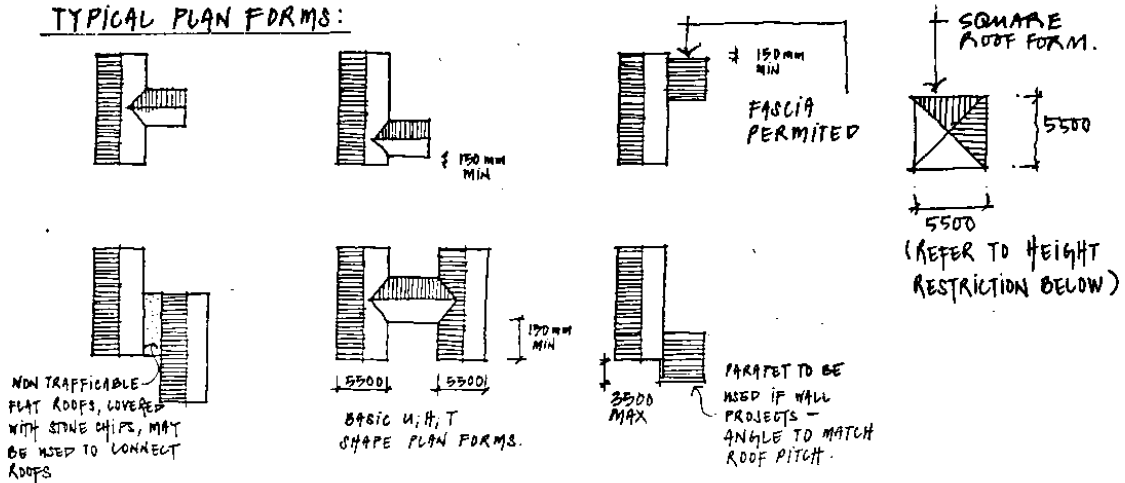

PLAN FORMS OF ROOFS SHOULD ONLY UTILISE THE FOLLOWING SHAPES / CONFIGURATIONS:

- SIMPLE RECTANGULAR FORMS
- COURTYARD FORMS
- BASIC T, U, L & H FORMS
- AND COMBINATIONS OF THE ABOVE

### TYPICAL SECTION:

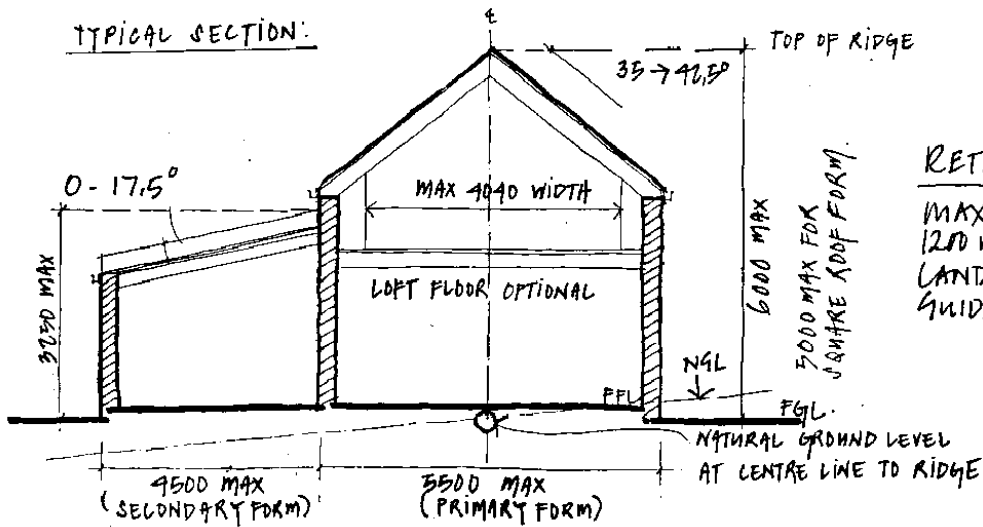

### RETAINING WALLS:

MAX HEIGHT TO BE 1200 MM (SEE LANDSCAPING GUIDELINES).

### ROOFS:

ALL PROPOSED HOUSE PLAN SOLUTIONS MUST UTILISE A 'PRIMARY ROOF FORM' THIS MAY BE INTERLINKED / CONNECTED VIA SECONDARY ROOF FORMS, TO ANOTHER PRIMARY ROOF FORM IF REQUIRED.

THE HEIGHT / WIDTH & LENGTH TOGETHER WITH ROOF ANGLES IS CONTROLLED IN ORDER TO AVOID LARGE MONOLITHIC TYPE BUILDING FORMS.

10.2 Control of Wall Lengths

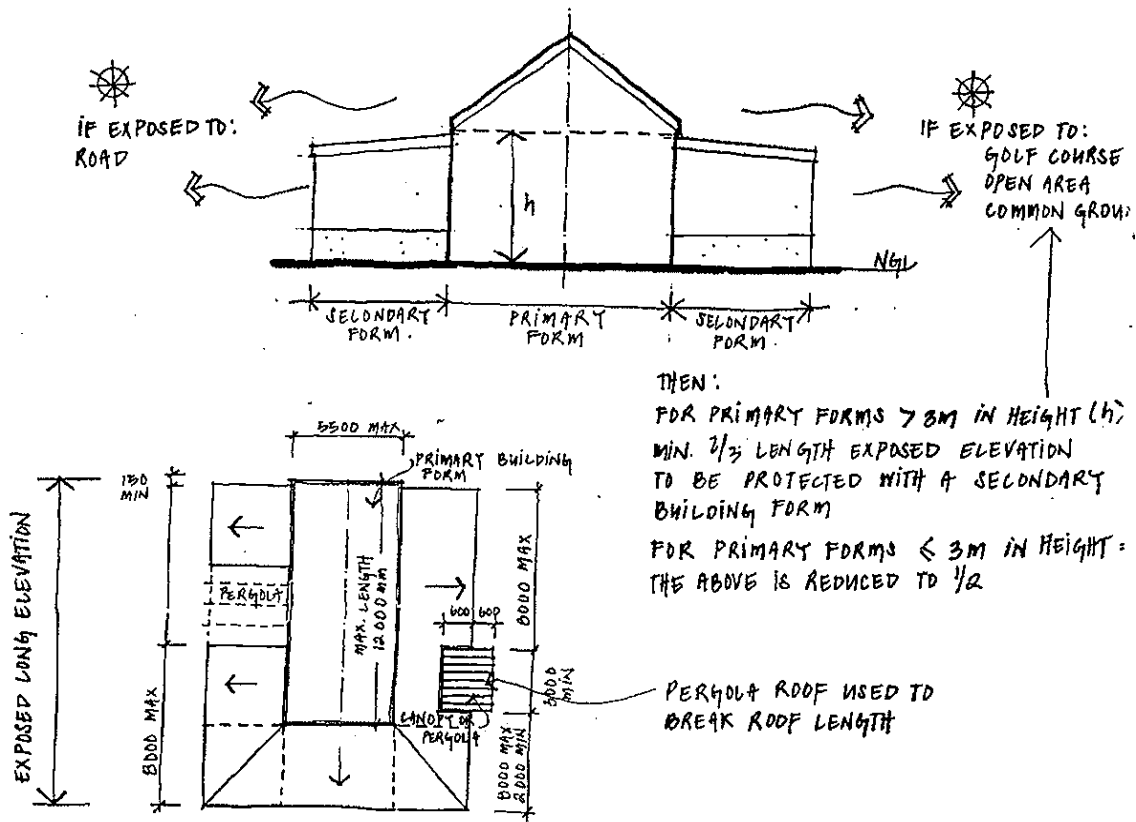

WALLS:

AREAS OF UNPROTECTED / BARE MASONRY WALLS ARE ALSO CONTROLLED IN AN EFFORT TO ENCOURAGE THE EXTENSIVE USE OF PERGOLA AND VERANDAS / STOEP / LEAN TO ROOFS / COURTYARDS / SCREEN WALLS.

CONNECTING ROOFS:

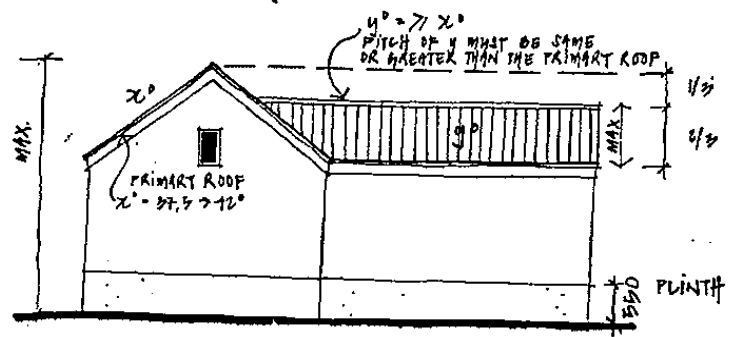

11. Treatment of Gable Ends

VARIOUS PERMITTED OPTIONS FOR THE TREATMENT OF GABLES & ENDING OF SECONDARY ROOF FORMS:

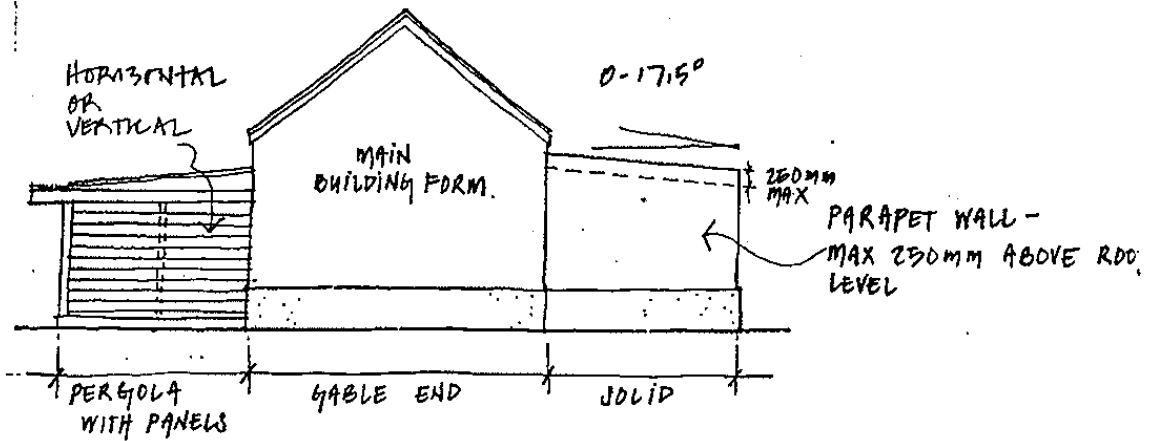
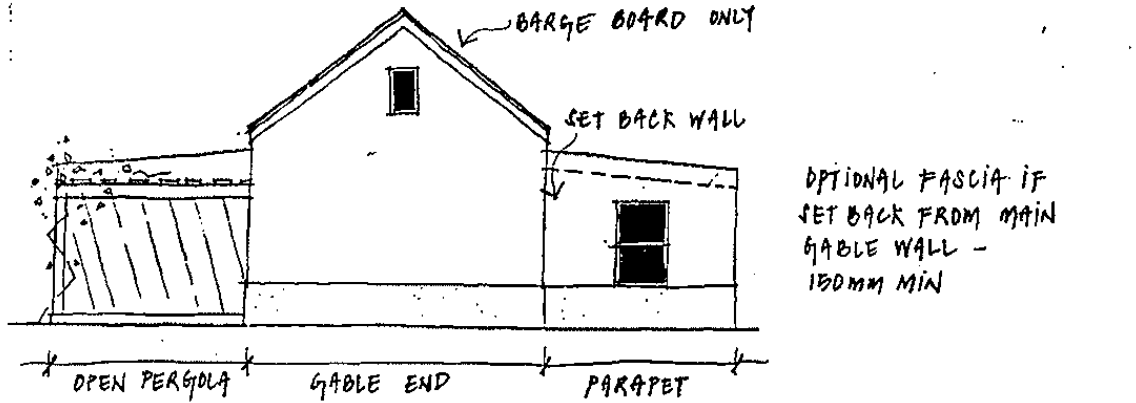

VERTICAL CLADDING:  
COVER STRIP TO BE  $\pm \frac{1}{3}$  WIDTH OF MAIN PLANK.

12. Verandahs

VERANDAHS ROOFS / WALL & SCREEN INFILL OPTIONS:

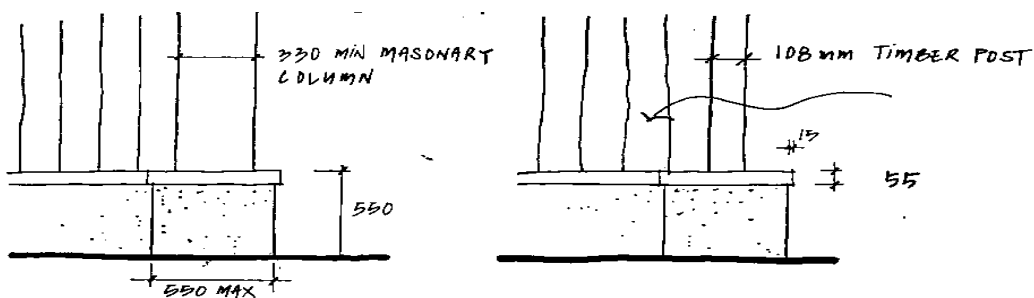
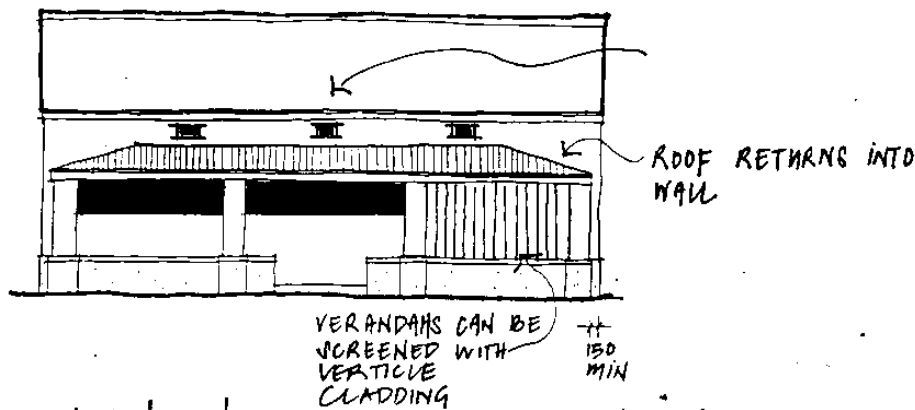
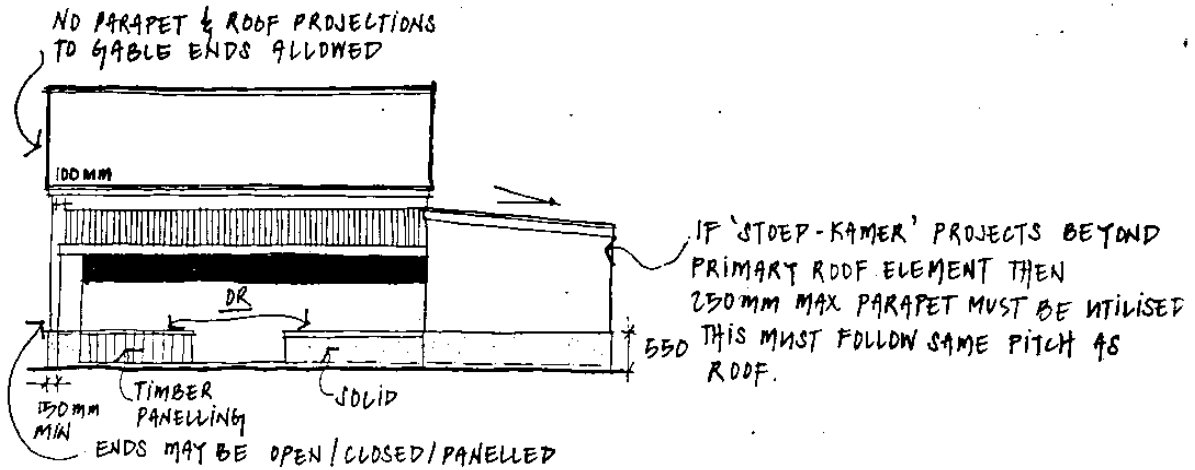

COLUMNS TO PLINTH VERANDAH WALL MAY VARY AS SHOWN ABOVE.

13.1 Openings

THE FOLLOWING TYPES OF OPENINGS ARE PERMITTED:

NOTE: - ROOF LIGHTS IN THE ROOF PLANE ARE PERMITTED  
 - NO DORMERS ARE PERMITTED

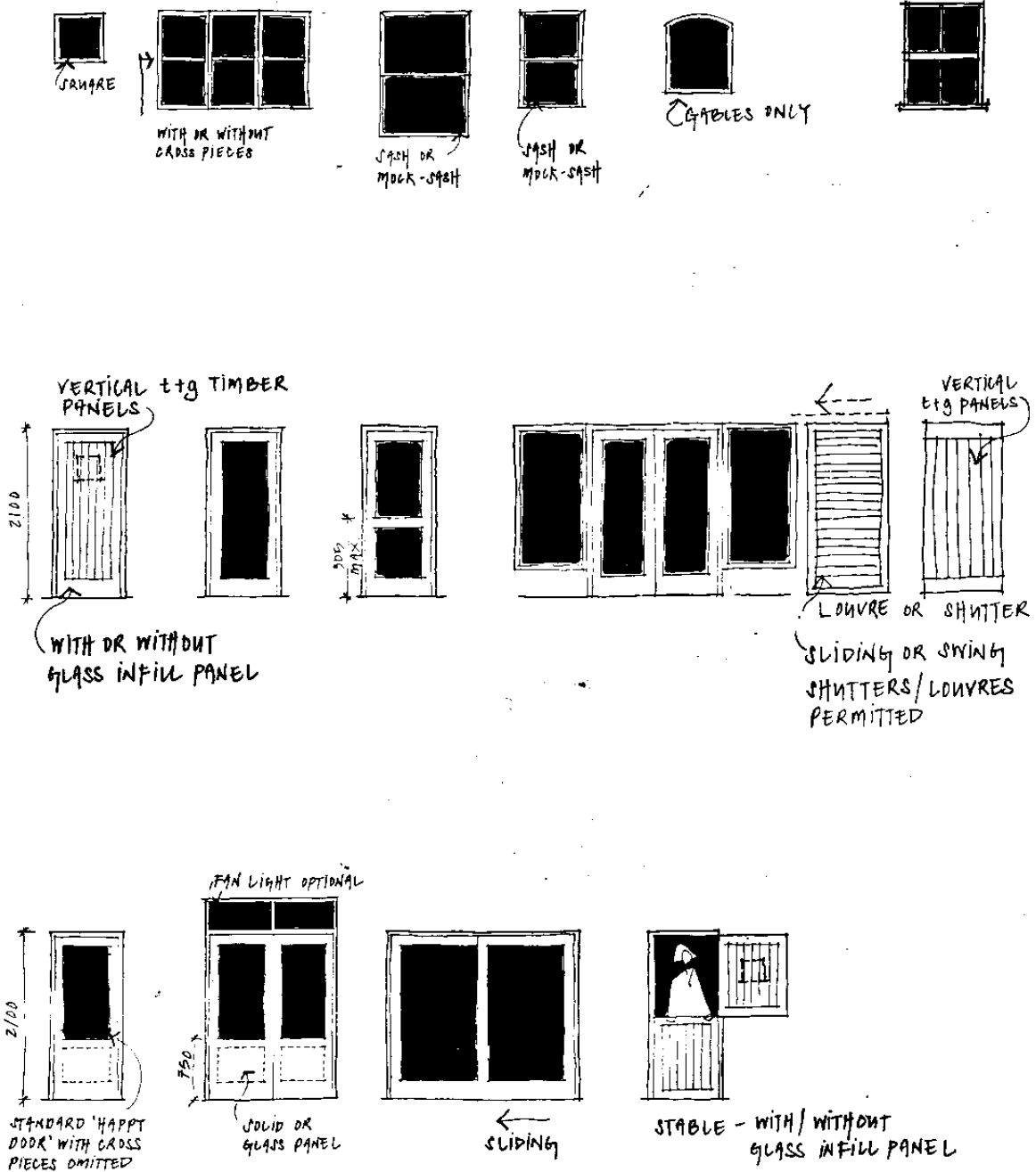

13.2 Openings

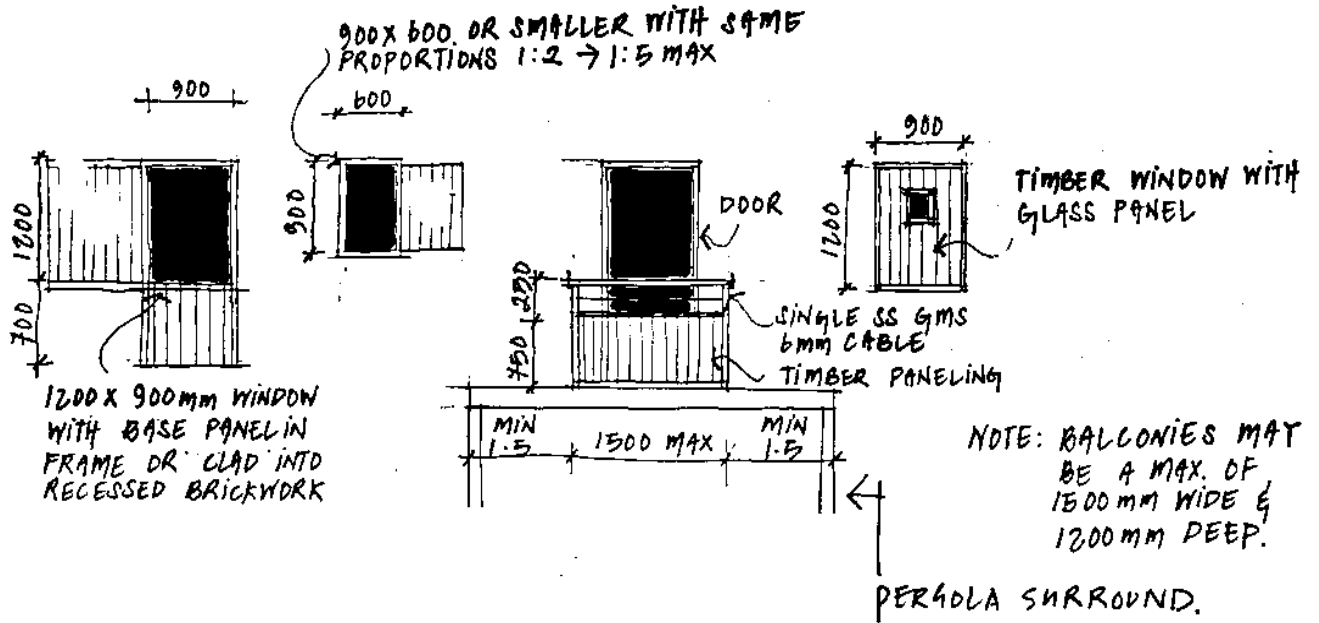

PERMITTED ENTRANCE DOORS: A + B  
 ALL VERTICAL TIMBER:

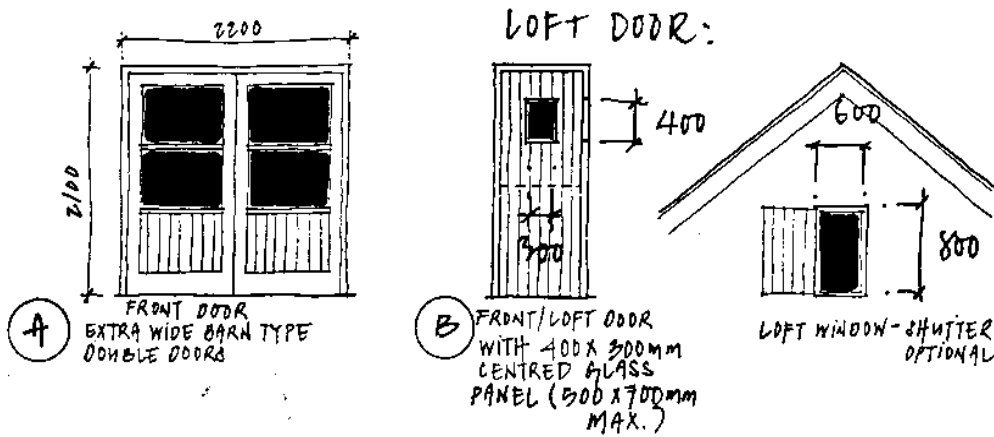

13.3 Openings

GABBLE END WINDOWS & VENTS:

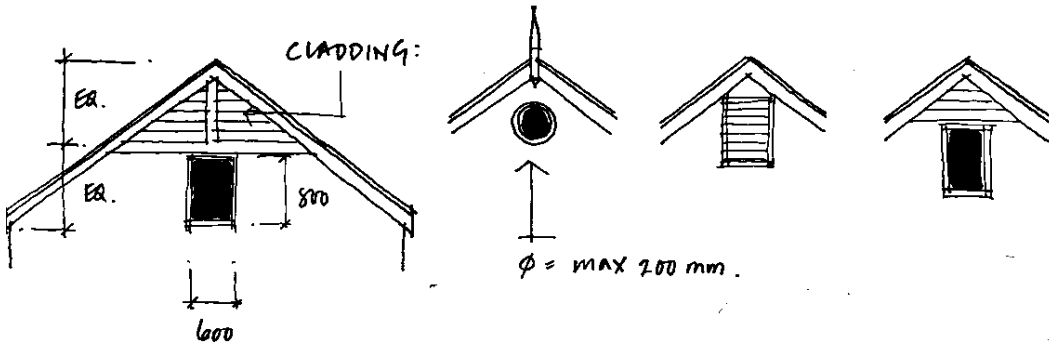

OTHER VENTS / WINDOWS & LOWPES:

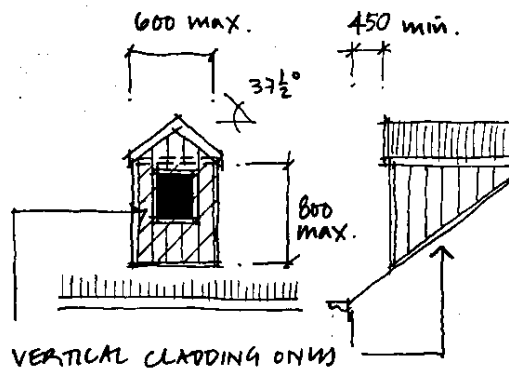
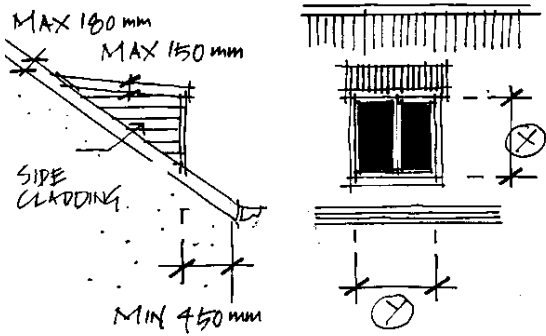
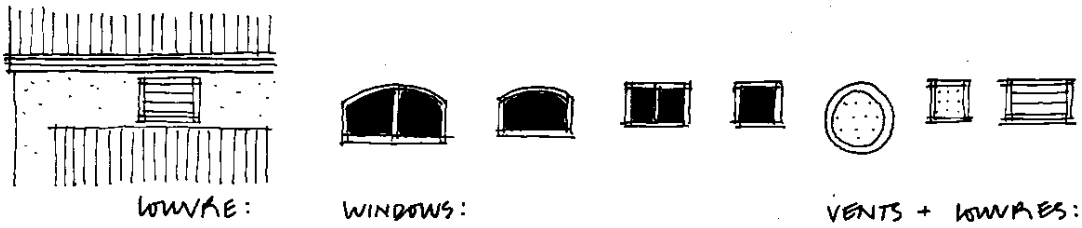

VARIOUS DORMER WINDOW  
DESIGNS MAY BE UTILISED -  
HORIZONTAL / VERTICAL CLADDINGS.

FRONT MAY BE GLASS OR  
WINDOW IN CLADDING.

14. Fascias/Parapets Walls & Eaves

THE FOLLOWING DETAILS ARE PERMITTED AT ROOF EDGES:

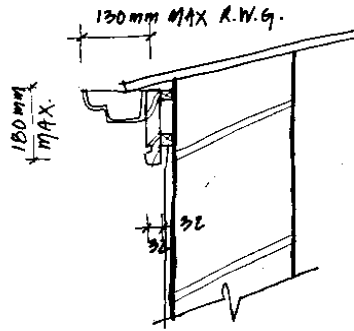
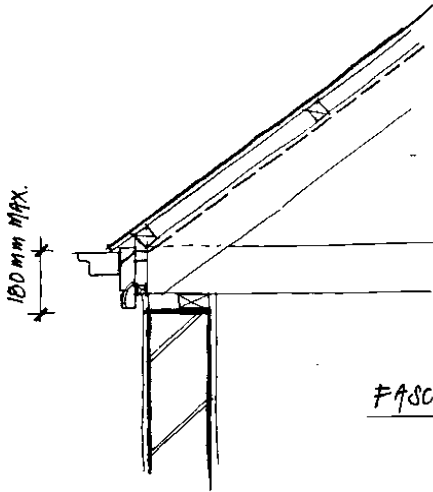

FASCIA CONDITIONS

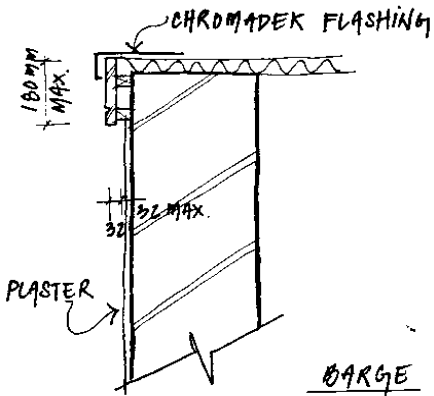

BARGE BOARD CONDITIONS

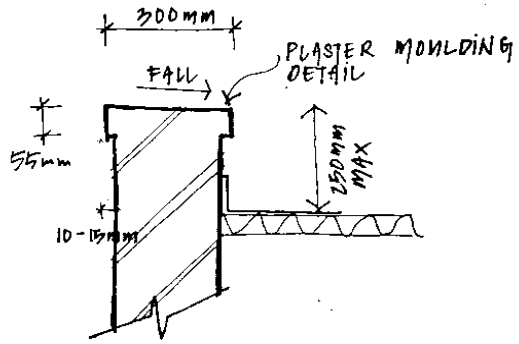

PARAPET CONDITION

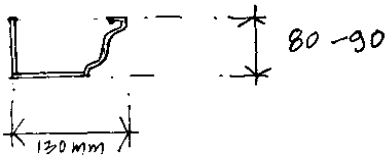

PERMITTED GUTTER PROFILES  
(IN CONTINUOUS ALUMINIUM TO COLOUR SPEC ONLY.)



15.1 Pergolas and Canopies

THE FOLLOWING ARE PERMITTED:

NOTE: PLANTING AREA AT EDGE OF STEPS ETC, MUST BE RETAINED

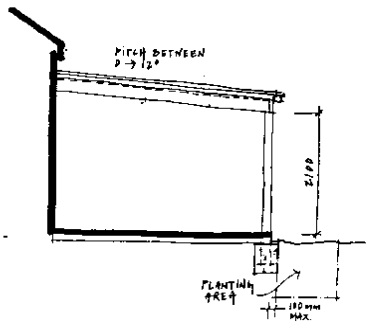
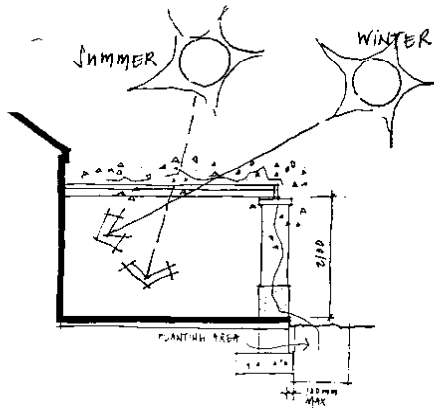
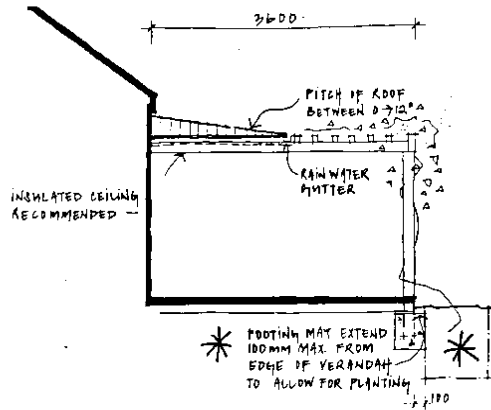
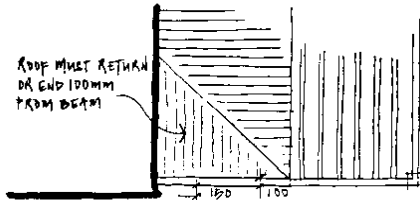
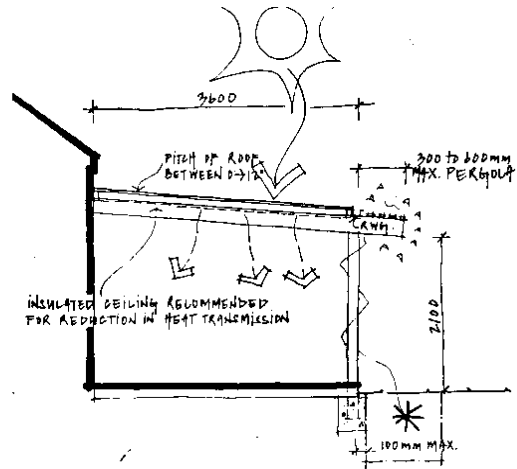

15.2 Pergolas and Canopies

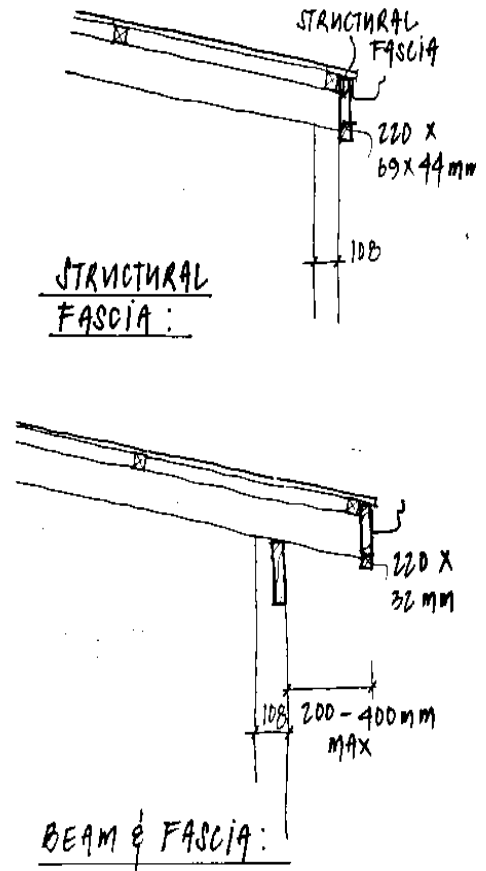
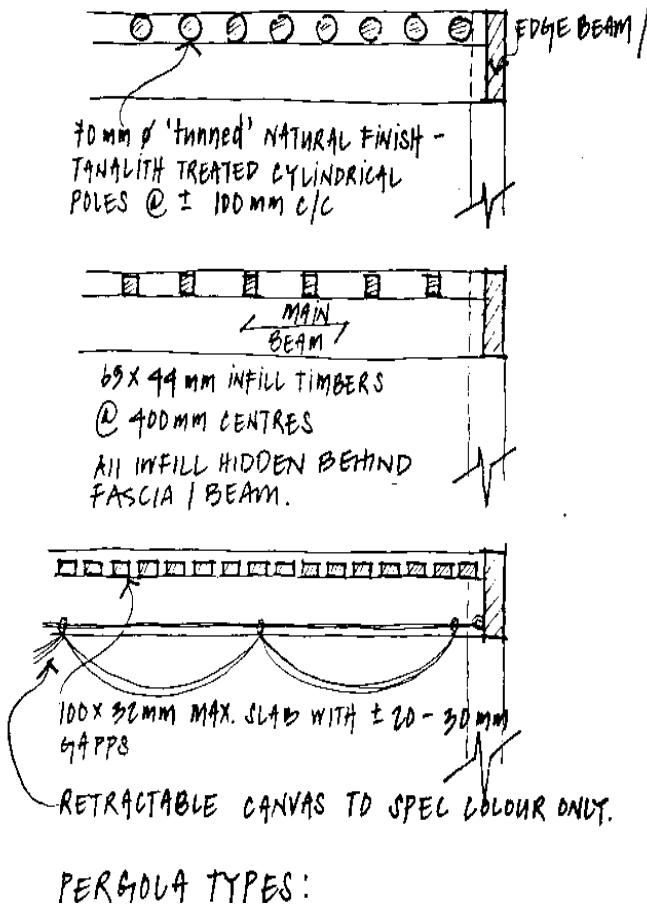

16. Fences/Gates and Wall Cladding Materials

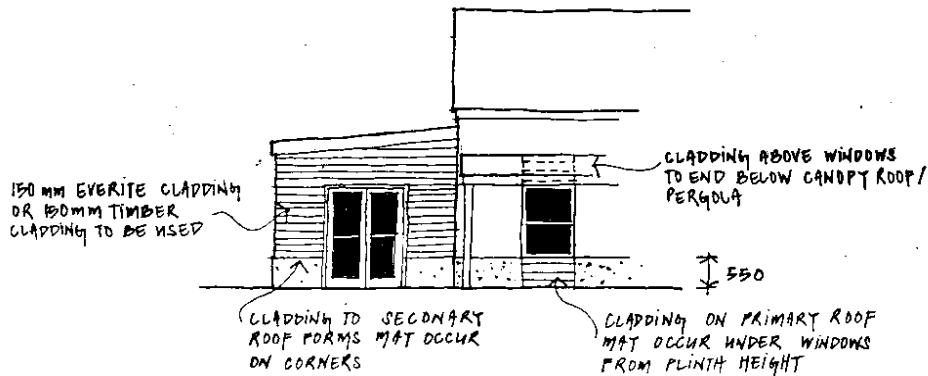
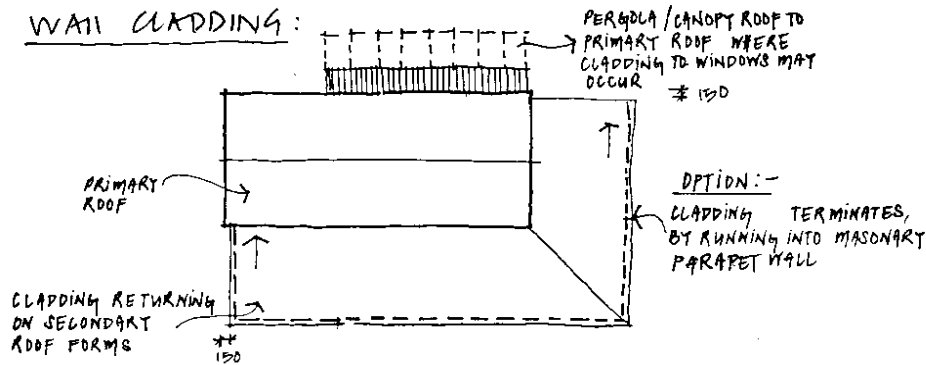
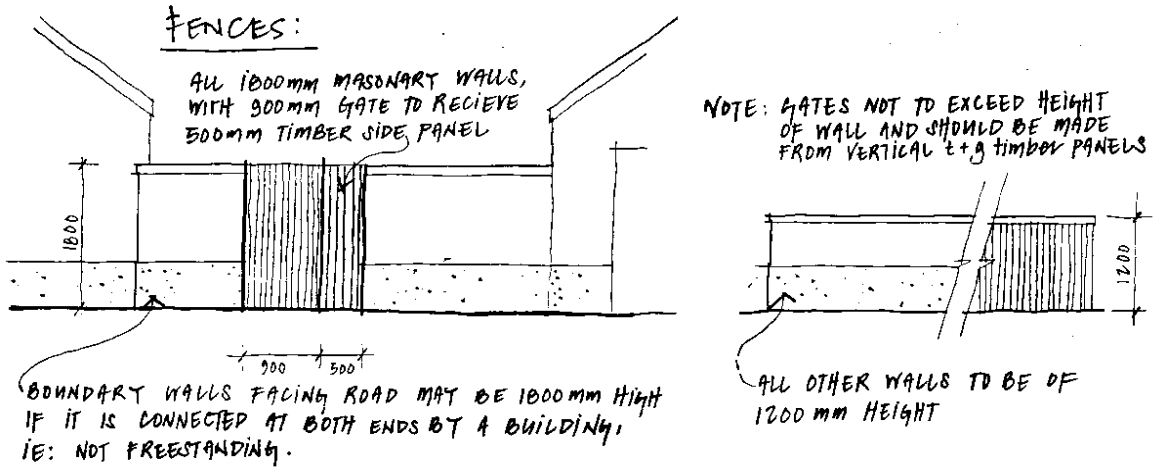

17. Boundary Walls

SECTION

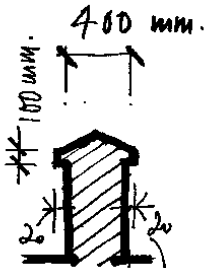

20 mm thick plaster band.  
(max 100 x 20 mm)

TYPICAL ELEVATION

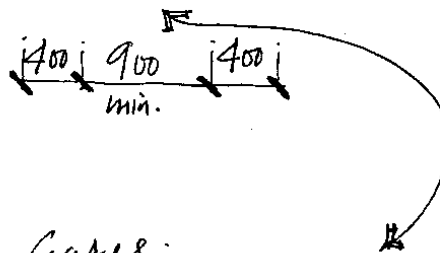
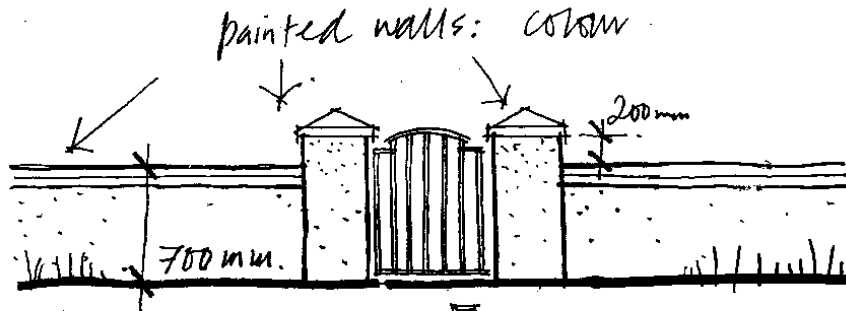

Gates:

Similar Gate designs are permitted: All to be painted black, unless in timber (tanalith or hard wood)

vertically laid tanalith timber

TYPICAL ELEVATION

tanalith post & rail.

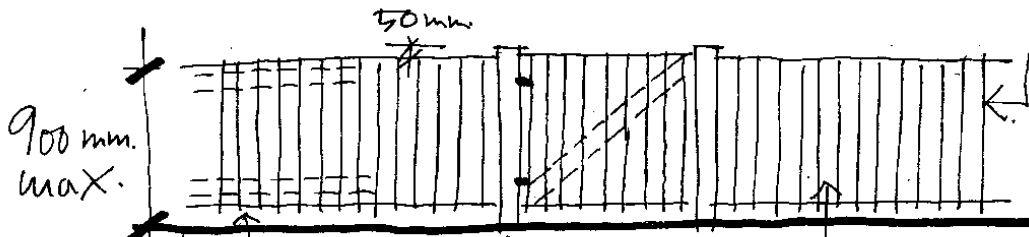

post & rail on house side: posts may be exposed @ Gates only.

tanalith T. posts. (square or round). Bracing on house/property side.

± 100 mm slats with 10-20mm gap max.

## 18. MATERIALS AND FINISHES

### Roof Coverings

All roofs are to be in Chromadek in the approved/specified colour as set out in the colour schedule.

### External Walls

All external walls are to be in plastered and painted brickwork or cladding. Stone walls are permitted in a dry packed type bond – design and position to be to the approval of the control Architects.

### External Cladding Infill Panels

All cladding to be Everite cladding panels or treated timber / hardwood.

### Fascias and Barge Boards

All to be to the details enclosed in this document finish to be painted or to match Chromadek colour.

### Doors and Windows

All doors and windows to be as per the details enclosed.

### External Timber generally

No timber is to be varnished – only stains or colours to the specification will be permitted.

### External Mild Steel Generally

All to be galvanized and painted

### Textured Paints

Textured paints – Earthcote/Chemwash are permitted in the colours allowed.

### Glass

No coloured glass will be permitted.

### Finishing of Braais and Chimneys

All to be as the main building form – see chimney details attached. All forms generally to be a simple arrangement of masonry forms to the approval of the control Architects.

### Shade Cloth

Only grey/beige shade cloth in the form of retractable systems underneath pergola arrangements will be permitted.

Note – The correct detailing of the envelope of the building using the recommended materials is the responsibility of the Architect appointed by the individual client.

## 19. COLOUR SCHEDULES

All of the paint colour references are from the MIDAS or PLASCON Colour ranges

### Roofs

Roofs are to be in a traditional small/Victorian profile corrugated iron profile. The colours that may be used are as follows:

**Dark Dolphin** from the **Chromadek** range or **Trojan Grey, Mineshaft**

Note - As an alternative to the above Tamco roof shingles in charcoal colours to be confirmed with the control architects may be used

External Walls

The colours that may be used are as follows:

**Rothko, Picasso, French Fry, White, Papyrus, Dockside, Winter Mist**

Other Building elements and trims

External feature colours may be used on the following building elements –

External cladding panels and screens  
Fascias and bargeboards  
Window and doorframes / shutters / garage doors  
Handrails and balustrades etc  
The colours that may be used are as follows

**Forest Night, Grand Bank, Blue Mask, Lunenburg, Pioneer Days, White**

Rainwater guttering

Rainwater guttering is to be in Black or Charcoal and only in continuous aluminum extrusion in the profile indicated – see item 15.

Rainwater downpipes may be Black or Charcoal or painted to match the wall colour.

Pergolas and Fences

Pergola structures/infill slats/poles and fences are to be in natural sealed hardwood or tanalith treated wood.

Canvas

Canvas shade cloth colours samples are to be confirmed with the control architect – only grey and beige colours will be permitted.

Walls

External boundary walls where permitted can only be painted in white.

Other elements

External metalwork and lights are to be in black.

Decking

Only natural hardwood decking or tanalith treated decking with a clear penetrating sealer is permitted - no varnishing will be allowed (max height to be 600mm above finished ground level).

External ceilings

Cane/read and painted timber ceilings are permitted in stoep areas.

**20. EXTERNAL LIGHTING**

Refer to the SHOA Landscaping Guidelines

**21. EXTERNAL SIGNAGE**

Refer to the SHOA Landscaping Guidelines

## 22. SERVICES

### Drainage:

All drainage except stub stacks shall be completely concealed within the building construction. Rainwater tanks are allowed but must be in a screened in approved positions.

### Aerials:

All TV aerials and satellite dishes shall be completely concealed or positioned to the approval of the SHOA – all satellite dishes are to be in a gray colour.

### Air Conditioning:

Air Conditioning units must be wall mounted at low level and screened from view.

### External Lighting/Numbering/Letterboxes (if applicable):

All to conform to the format agreed with the SHOA.

### Dog Kennels / Washing Lines / Refuse Bins etc.:

All to be screened behind an 1800mm screen/wall or to be located in a service yard/courtyard type arrangement.

### Storage of other items:

No stored materials or items shall be visible from a common area – all to be screened/stored internally.

### Trailers/Boats/Caravans etc.:

All to be parked/stored either in a garage or screened carport or in an approved position which is not visible from any common areas in the development

### Solar Heating:

Only panels that are flush with the roof plain shall be permitted at the discretion of the SHOA. Color to be gray/black or the same as the roof sheeting - no water storage tanks shall be permitted unless at ground level and completely screened from view.

### Electrical Boxes and Similar

All electrical boxes and similar are to be recessed and/or screened from view.

## 23. ADDENDUMS

### ADDENDUM 1

SANS 10400XA Compulsory energy saving regulations  
Kind reminder to owners & designers at Silverstrand Golf & River Estate

In order to streamline house designs / the plan approval process & avoid changes to drawings at a late stage - it is suggested that the following new regulations be taken into account **EARLY ON** in the sketch design phase of plan preparation - main areas as follows:

#### Building Orientation

Major windows (to main living spaces) to be oriented to the North where possible - if this is not possible - other energy saving mechanisms may come into play.

Best orientation is true North and up to +20 degrees East and +8 degrees West

Up to +22.5 degrees East or West is okay

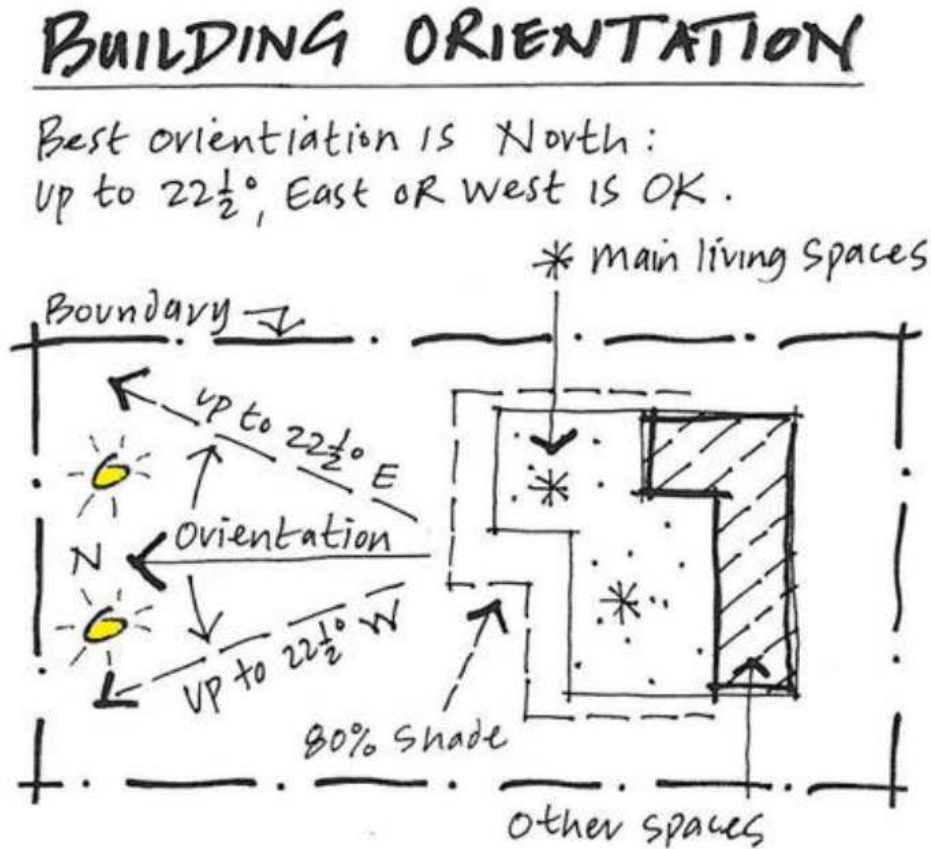



### Floors

Underfloor heating if utilized MUST have insulated floors

### External Walls

Insulation is recommended but NOT compulsory

### Fenestration

Deemed to satisfy regulations state a max 15% of floor area is allowed for glazing  
(Calculations must be submitted to council otherwise)

Windows must conform to Air infiltration & Thermal transmission standards

Glass types must be specified

### Roof lights

Will be taken into account within the 15% allowance mentioned above

### Shading / Radiation requirements

Roof eaves or other shading devices are to provide 80% shading of summer radiation of North / East and West sides - canopy roofs & pergolas etc are all acceptable subject to calculation

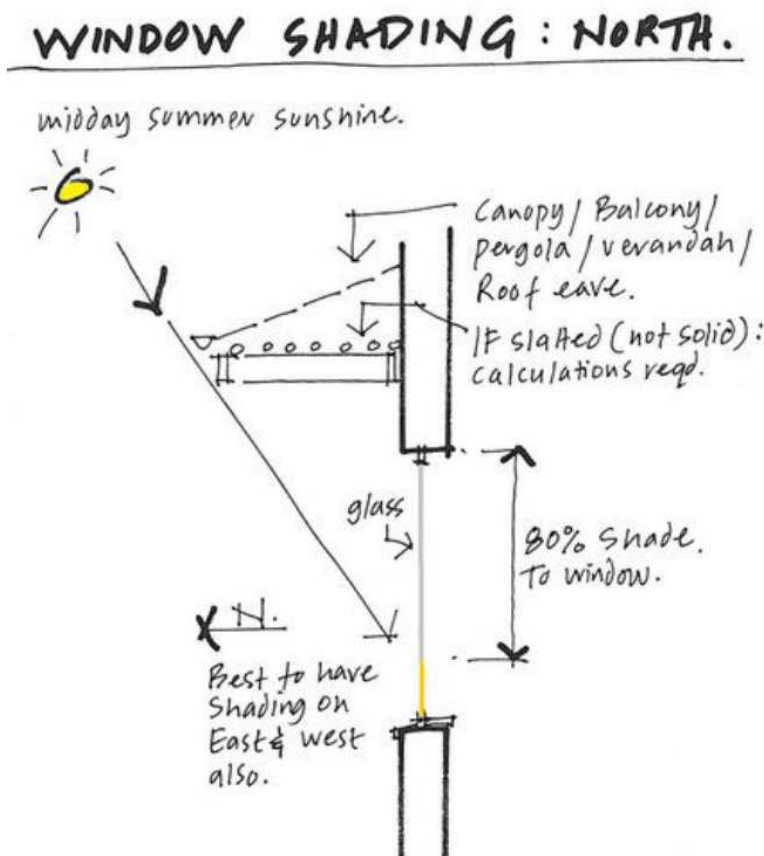

### Roof assemblies

Type of roof construction will affect the thermal calculations and ease of compliance - especially in the case of lofts

### Lighting and power

Low energy lighting internally will comply  
High pressure sodium externally will comply

### Hot water services

50% of annual hot water consumption MUST be from renewable power - Solar water heaters or Heat pumps etc

Solar water heaters should be positioned where best hidden from view from neighbours and street &/or screened from view

## SOLAR HOT WATER HEATING.

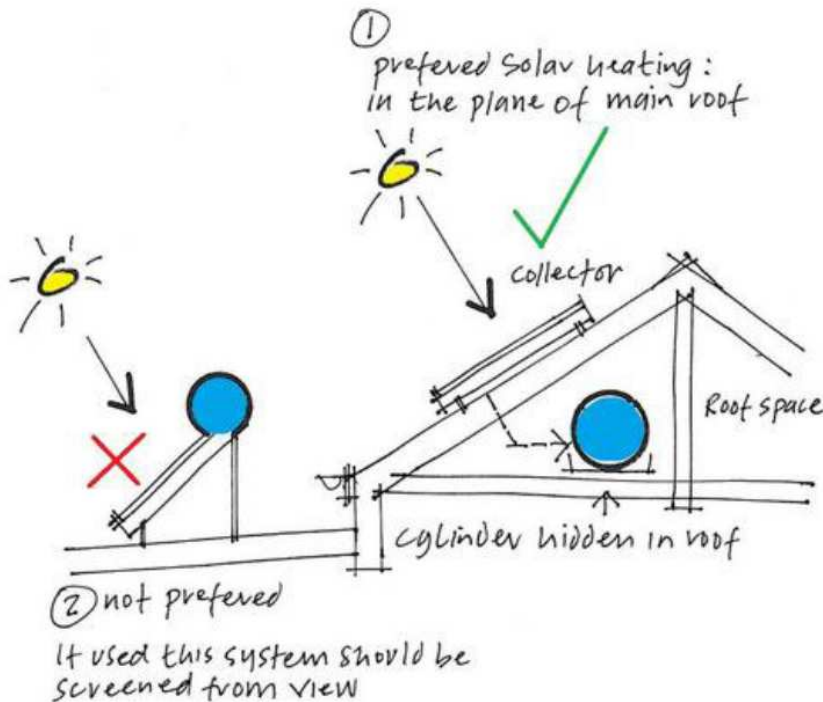

### Mechanical ventilation / air conditioning & heating equipment

If required to achieve regulations will need screening

Note - the above is not necessarily a conclusive list - all Architects & Designers should refer to the Energy Regulations SANS 10400XA

## ADDENDUM 2

### 10.1 Primary and Secondary Building Forms

The maximum height of the building may be increased from 6m to 6.5m in height.

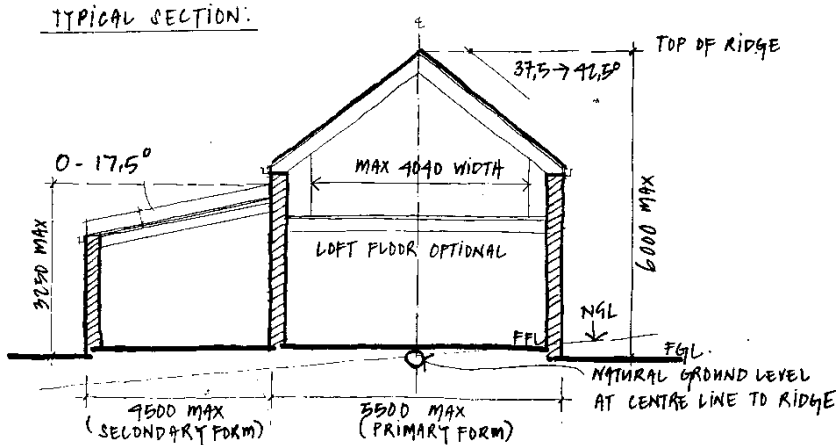

#### ROOFS:

ALL PROPOSED HOUSE PLAN SOLUTIONS MUST UTILISE A 'PRIMARY ROOF FORM'. THIS MAY BE INTERLINKED / CONNECTED VIA SECONDARY ROOF FORMS, TO ANOTHER PRIMARY ROOF FORM IF REQUIRED.

THE HEIGHT / WIDTH & LENGTH TOGETHER WITH ROOF ANGLES IS CONTROLLED IN ORDER TO AVOID LARGE MONOLITHIC TYPE BUILDING FORMS.

## ADDENDUM 3

### 9.2 Outbuildings / Garaging and Parking requirements

A submission may be made with full motivation if there is a requirement for a double garage door. If the control architect deems the request for a double garage door to have architectural merit it will be allowed. A comprehensive motivation must be submitted to the Control Architect for consideration and written permission will be provided if deemed appropriate. If there is no architectural merit in the application, single garage doors must be installed as per the Guidelines 10.1.

## ADDENDUM 4

### 17. Boundary walls

The middle section of all side perimeter walls that are free standing and not attached on either side to a building, may be up to a maximum of 1.8m in height.

## ADDENDUM 5

It is compulsory for the side perimeter wall, where the court yard is located, to be built and for the submitted plans to reflect such.

**ADDENDUM 6**

The maximum height of garages with a pitched roof may be increased from 4.25m to 4.5m

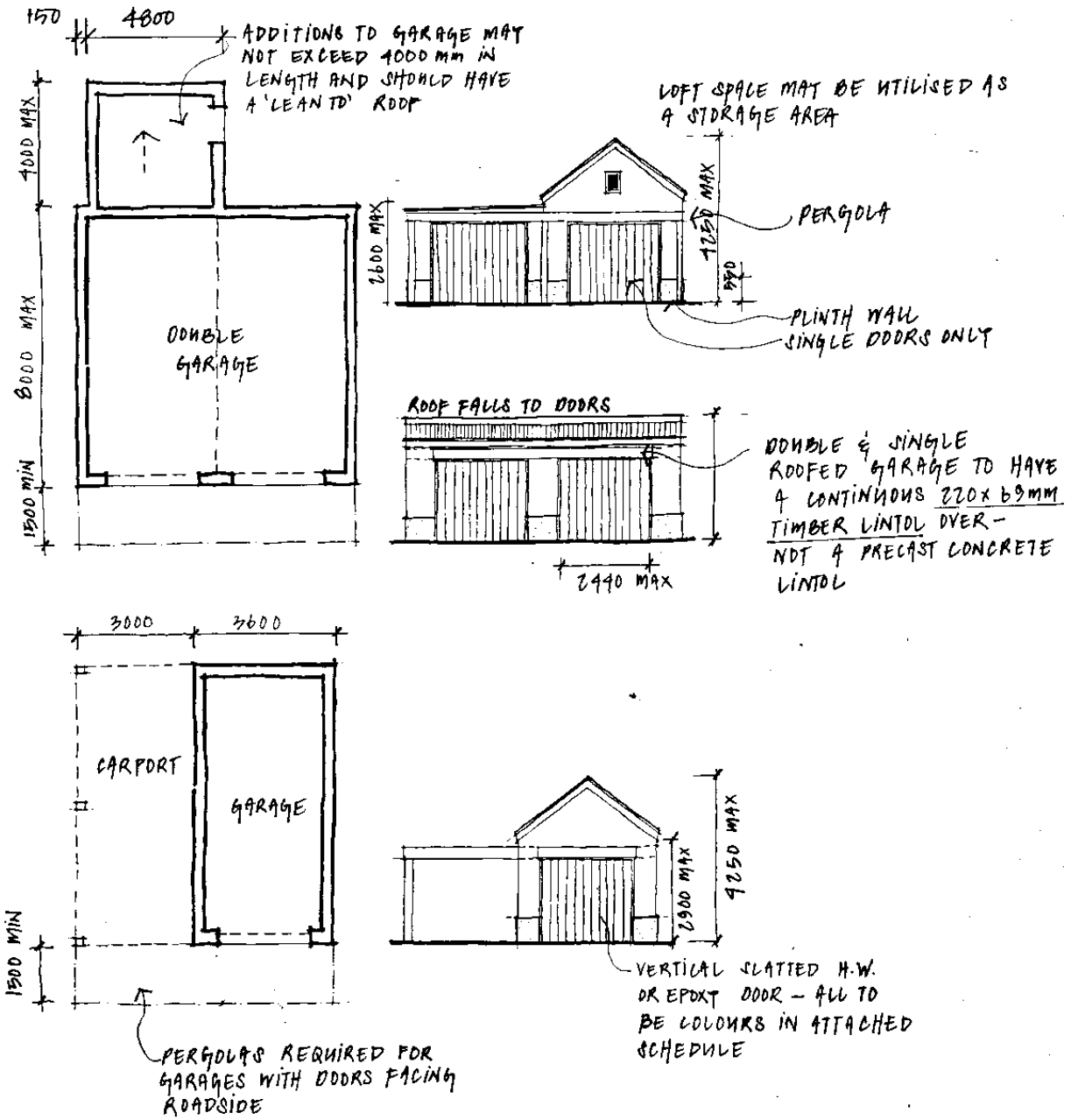

## ADDENDUM 7

### 8. Site and Boundary conditions

The minimum size of a property in the Village, including “stoepe” is 150m<sup>2</sup> for single storey dwellings.

## ADDENDUM 8

### 17. Boundary walls

The minimum height for a boundary wall enclosing a swimming pool is 1.2m as required by the National Building Regulations (Clause 4.4.1).

A solid wall with a minimum height of 300mm and a maximum height of 600mm with a picket fence on top making up the difference in height to 1.2m, is acceptable to serve as a boundary wall/fence whether it encloses a pool or not. Picket fences may be white or natural wood.

The following palisade type fencing would also be acceptable:

1. A plastered and painted brick base wall of 600 mm height and 230 mm width with 345 mm X 345 mm X 1 200 mm high plastered and painted brick columns at 2,5 meters intervals;
2. Two horizontal rails of 38mm X 38mm X 2mm square tubing;
3. Vertical palisades of 25mm X 25mm X 2mm minimum square tubing (480mm in length) at maximum 100mm intervals;
4. Metal lugs (at the ends of the horizontal rails) of 32mm X 3mm must be fixed to the columns with 8mm Ø stainless steel bolts and PVC anchors.
5. Palisade panels must be finished off with a suitable self-etch primer and enamel paint.

